

MAZKO ENTERPRISES



PRODUCT CATALOG

Comprehensive catalog showcasing innovative, high-quality products along with technical specifications.

WWW.MAZKO.IN



RIGGING SOLUTIONS

U.S. TYPE ANCHOR SHACKLES



G-209



G-2130

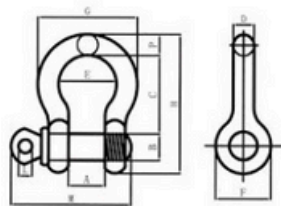

Screw pin anchor shackle meet the requirements of Federal Specification RR-C-271D Type IVA, Grade A, Class 2

Safety anchor shackle with hexagon bolt-nut and cotter pin meet the requirements of Federal Specification RR-C-271D Type IVA, Grade A, Class 3

Nominal Size (in.)	WLL (t)	Weight Each (kg)	Dimensions(mm)											Tolerance +/-	
			A	B	C	D	E	F	G	H	L	M	P	C	A
3/16	0.3	0.03	9.65	6.35	22.4	4.85	15.2	14.2	24.9	37.3	4.06	28.4	4.85	1.50	1.50
1/4	0.5	0.05	11.9	7.85	28.7	6.35	19.8	15.5	32.5	46.7	4.85	35.1	6.35	1.50	1.50
5/16	0.75	0.09	13.5	9.65	31.0	7.85	21.3	19.1	37.3	53.0	5.60	42.2	7.85	3.30	1.50
3/8	1	0.14	16.8	11.2	36.6	9.65	26.2	23.1	45.2	63.0	6.35	51.5	9.65	3.30	1.50
7/16	1.5	0.17	19.1	12.7	42.9	11.2	29.5	26.9	51.5	74.0	7.85	60.5	11.2	3.30	1.50
1/2	2	0.33	20.6	16.0	47.8	12.7	33.3	30.2	58.5	83.5	9.65	68.5	12.7	3.30	1.50
5/8	3.25	0.62	26.9	19.1	60.5	16.0	42.9	38.1	74.5	106	11.2	85.0	17.5	6.35	1.50
3/4	4.75	1.07	31.8	22.4	71.5	19.1	51.0	46.0	89.0	126	12.7	101	20.6	6.35	1.50
7/8	6.5	1.64	36.6	25.4	84.0	22.4	58.0	53.0	102	148	12.7	114	24.6	6.35	1.50
1	8.5	2.28	42.9	28.7	95.5	25.4	68.5	60.5	119	167	14.2	129	26.9	6.35	1.50
1-1/8	9.5	3.36	46.0	31.8	108	29.5	74.0	68.5	131	190	16.0	142	31.8	6.35	1.50
1-1/4	12	4.31	51.5	35.1	119	32.8	82.5	76.0	146	210	17.5	156	35.1	6.35	1.50
1-3/8	13.5	6.14	57.0	38.1	133	36.1	92.0	84.0	162	233	19.1	174	38.1	6.35	3.30
1-1/2	17	7.80	60.5	41.4	146	39.1	98.5	92.0	175	254	20.6	187	41.1	6.35	3.30
1-3/4	25	12.6	73.0	51.0	178	46.7	127	106	225	313	25.4	231	57.0	6.35	3.30
2	35	20.4	82.5	57.0	197	53.0	146	122	253	348	31.0	263	60.0	6.35	3.30
2-1/2	55	38.9	105	70.0	267	69.0	184	145	327	453	35.1	330	79.5	6.35	6.35
3	85	66	127	83	330	76	200	165	365	540	41	419	97	6.35	6.35
3-1/2	120	108	133	96	372	92	229	203	419	600	46	482	105	6.35	6.35
4	150	150	140	108	368	104	254	229	468	620	50	502	116	6.35	6.35

U.S. TYPE CHAIN SHACKLES



G-210



G-2150

Screw pin chain shackle meet the requirements of Federal Specification RR-C-271D Type IVB, Grade A, Class 2

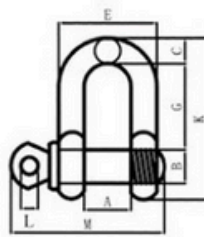

Safety chain shackle with hexagon bolt-nut and cotter pin meet the requirements of Federal Specification RR-C-271D Type IVB, Grade A, Class 3

Nominal Size (in)	WLL (t)	Weight Each (kg)	Dimensions(mm)										Tolerance +/-	
			A	B	C	D	E	F	G	K	L	M	G	A
1/4	0.5	0.05	11.9	7.85	6.35	6.35	24.6	15.5	22.4	40.4	4.85	35.1	1.50	1.50
5/16	0.75	0.08	13.5	9.65	7.85	7.85	29.5	19.1	26.2	48.5	5.60	42.2	1.50	1.50
3/8	1	0.13	16.8	11.2	9.65	9.65	35.8	23.1	31.8	58.5	6.35	51.5	3.30	1.50
7/16	1.5	0.20	19.1	12.7	11.2	11.2	41.4	26.9	36.6	67.5	7.85	60.5	3.30	1.50
1/2	2	0.27	20.6	16.0	12.7	12.7	46.0	30.2	41.4	77.0	9.65	68.5	3.30	1.50
5/8	3.25	0.57	26.9	19.1	15.7	16.0	58.5	38.1	51.0	95.5	11.2	85.0	3.30	1.50
3/4	4.75	1.20	31.8	22.4	20.6	19.1	70.0	46.0	60.5	115	12.7	101	6.35	1.50
7/8	6.5	1.43	36.6	25.4	24.6	22.4	81.0	53.0	71.5	135	12.7	114	6.35	1.50
1	8.5	2.15	42.9	28.7	25.4	25.4	93.5	60.5	81.0	151	14.2	129	6.35	1.50
1-1/8	9.5	3.06	46.0	31.8	31.8	28.7	103	68.5	91.0	172	16.0	142	6.35	1.50
1-1/4	12	4.11	51.5	35.1	35.1	31.8	115	76.0	100	191	17.5	156	6.35	3.30
1-3/8	13.5	5.28	57.0	38.1	38.1	35.1	127	84.0	111	210	19.1	174	6.35	3.30
1-1/2	17	7.23	60.5	41.4	41.1	38.1	137	92.0	122	230	20.6	187	6.35	3.30
1-3/4	25	12.1	73.0	51.0	54.0	44.5	162	106	146	279	25.4	231	6.35	3.30
2	35	19.2	82.5	57.0	60.0	51.0	184	122	172	312	31.0	263	6.35	3.30
2-1/2	55	32.5	105	70.0	66.5	66.5	238	145	203	377	35.1	330	6.35	6.35
3	85	66	127	83	330	76	200	165	365	540	41	419	6.35	6.35
3-1/2	120	108	133	96	372	92	229	203	419	600	46	482	6.35	6.35

JIS SHACKLE

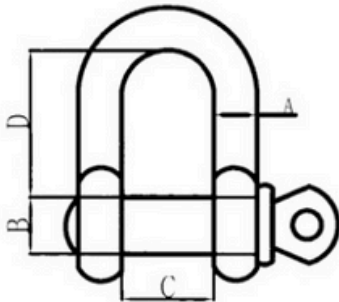

SIZE	Dimensions (mm)				WLL	WEIGHT (kg)
	A	B	C	D		
M6	6.8	6.5	16.5	25.0	0.02T	0.037
M8	7.0	6.7	16.5	29.0	0.05T	0.045
M10	8.9	9.0	20.0	35.0	0.1T	0.081
M12	9.1	11.0	26.0	50.0	0.2T	0.141
M14	11.3	12.0	25.1	52.0	0.5T	0.2
M16	14.0	15.0	28.4	54.0	0.8T	0.34
M18	15.2	16.5	30.0	63.0	1T	0.5
M20	17.5	19.0	32.0	65.5	1.5T	0.681
M22	19.8	21.0	35.0	73.0	2T	0.875
M25	22.0	24.0	40.0	82.0	2.5T	1.276
M28	25.0	27.0	52.0	99.5	3T	1.994
M30	27.5	29.8	47.8	97.0	3.5T	2.39
M32	30.0	31.0	55.0	99.5	4T	3
M36	31.8	35.0	62.5	114.0	5T	4.038
M38	34.2	38.2	65.0	114.0	6T	4.75
M42	38.0	41.5	69.9	126.0	7T	5.07
M45	45.0	50.0	81.0	153.0	8T	7.7
M50	45.0	50.0	83.5	154.0	10T	10.8

HEAVY DUTY SHACKLE

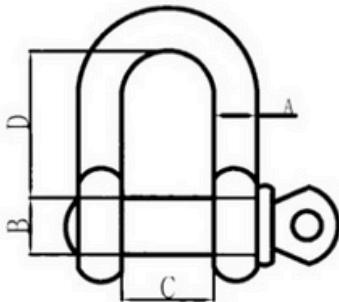

SIZE	Dimensions(mm)				WLL	WEIGHT (kg)
	A	B	C	D		
0.5T	12	13.0	20.0	35.0	0.5T	0.187
0.9T	14	15	22	47	0.9T	0.248
1.1T	14	15	27.0	51.0	1.1T	0.339
1.4T	15	18	32.5	66	1.4T	0.484
1.8T	16	20.5	35.2	70	1.8T	0.62
2.1T	18	21.5	39	78	2.1T	0.805
2.7T	21.5	24.8	40	82	2.7T	1.265
3.3T	25	27	49	101	3.3T	1.92
4.1T	28	30	48	96.8	4.1T	2.49
4.9T	31	33.8	58	117.5	4.9T	3.4
5.5T	32	33.3	54	123	5.5T	3.79
6.8T	34.5	38.5	65.2	117	6.8T	5.06
9.5T	40	43	74	140.5	9.5T	7.52
10.7T	45	48	80.5	156	10.7T	10.6
16T	50	53	80	176	16T	12.8
20T	51	62	91	162	20T	15.3

BLACKE HEAVY DUTY SHACKLE

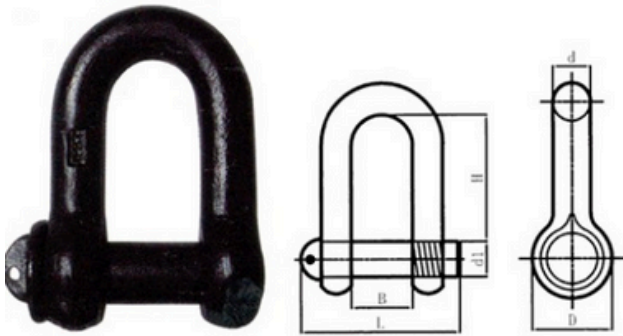

Size	Dimensions (mm)				
(t)	dl	d	L	B	H
0.9	M16	12	65	24	60
1.4	M20	16	86	32	80
2.1	M24	20	101	36	90
2.7	M27	22	111	40	100
3.3	M30	24	123	45	110
4.1	M33	27	137	50	120
4.9	M36	30	153	58	130
6.8	M42	36	176	64	150
9.5	M48	42	197	70	170
10.7	M52	45	218	80	190
16	M64	52	262	99	235
20	M76	65	321	100	256

EUROPEAN TYPE LARGE DEE SHACKLE

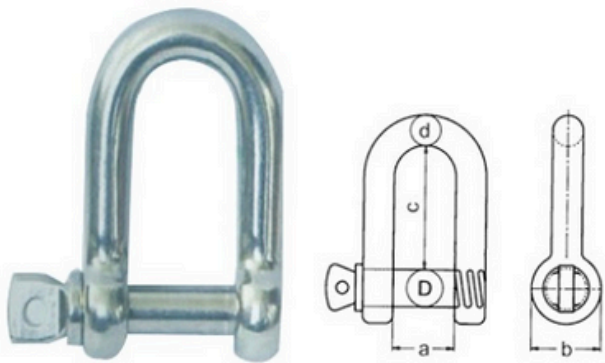

SIZE	SWL kg	D MM	d MM	a MM	c MM	b MM	WEIGHT PER 100 PCS (kg)
5	80	5	5	10	19	11	1.85
6	100	6	6	13	25	11	3.3
8	200	8	8	16	32	18	6.8
10	320	10	10	19	38	20	12.6
12	520	12	12	25	51	26	23
16	800	16	16	32	64	33	48.5
20	1100	20	20	38	76	40	78
22	1500	22	22	44	89	50	126
25	2100	25	25	51	100	57	194
28	3000	28	28	57	115	68	291
32	3500	32	32	64	127	73	417
38	5000	38	38	76	152	85	655
45	7000	45	45	90	180	96	1213
50	8000	50	50	102	200	108	1698

EUROPEAN TYPE LARGE BOW SHACKLE

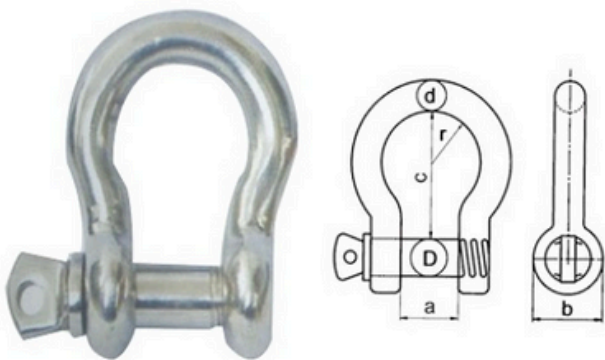

SIZE	SWL kg	D mm	d mm	a mm	c mm	r mm	b mm	WEIGHT PER 100 PCS (kg)
5	80	5	5	10	19	8	11	1.9
6	100	6	6	13	25	10	14	3.4
8	200	8	8	16	32	12	18	7
10	320	10	10	19	38	16	20	13
12	520	12	12	25	51	19	26	26
16	800	16	16	32	64	28	33	50
20	1100	20	20	38	76	33	40	80
22	1500	22	22	44	89	37	50	130
25	2100	25	23	51	100	40	57	200
28	3000	28	28	57	115	47	68	310
32	3500	32	32	64	127	52	73	430
38	5000	38	38	76	152	63	85	700
45	7000	45	45	90	180	75	96	1250

US TYPE TURNBUCKLES WITH EYE & JAW

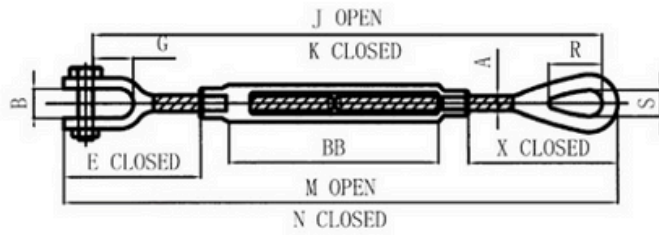

Drop Forged, Quenched and Tempered
Hot Dipped Galvanized

Proof Load is 2.5 times the Working Load Limit. Ultimate Load is 5 times the Working Load Limit.

Size(in)	WLL (T)	Weight (KG)	Dimensions(mm)											
			A	D	E Closed	G	J Open	K Closed	M Open	N Closed	R	S	X Closed	BB
1/4*4	0.23	0.14	6.35	11.4	40.1	15.7	288	187	307	205	19.8	865	445	101
5/16*4 1/2	0.36	0.23	7.85	12.7	50.5	22.1	348	221	356	242	23.8	11.1	53.0	114
3/8*6	0.54	0.36	9.65	13.7	54.0	22.1	427	275	451	299	28.4	13.4	640	152
1/2*6	1.00	0.68	12.7	16.5	70.0	26.9	490	312	520	342	36.5	18.2	82.0	152
1/2*9	1.00	0.78	12.7	16.5	70.0	26.9	642	388	673	419	36.5	18.2	82.0	228
1/2*12	1.00	0.94	12.7	16.5	70.0	26.9	795	465	825	495	36.5	18.2	82.0	304
5/8*6	1.59	1.07	16.0	20.1	89.0	33.3	533	349	572	388	44.4	22.3	99.0	152
5/8*9	1.59	1.44	16.0	20.1	89.0	33.3	686	425	725	464	44.4	22.3	99.0	228
5/8*12	1.59	1.64	16.0	20.1	89.0	33.3	838	501	877	541	44.4	22.3	99.0	304
3/4*6	2.36	1.81	19.1	23.9	106	38.1	576	386	625	435	53.0	25.4	119	152
3/4*9	2.36	2.15	19.1	23.9	106	38.1	729	462	777	511	53.0	25.4	119	228
3/4*12	2.36	2.69	19.1	23.9	106	38.1	881	538	930	587	53.0	25.4	119	304
3/4*18	2.36	3.18	19.1	23.9	106	38.1	1186	691	1235	739	53.0	25.4	119	457
7/8*12	3.27	3.79	22.4	28.7	123	44.5	917	567	973	624	60.4	31.7	130	304
7/8*18	3.27	4.42	22.4	28.7	123	44.5	1221	720	1278	776	60.4	31.7	130	457
1*6	4.54	4.05	25.4	34.0	140	52.5	669	466	734	531	76.0	36.5	162	152
1*12	4.54	5.08	25.4	34.0	140	52.5	974	618	1039	683	76.0	36.5	162	304
1*18	4.54	6.03	25.4	34.0	140	52.5	1279	771	1343	835	76.0	36.5	162	457
1*24	4.54	7.71	25.4	34.0	140	52.5	1583	923	1648	988	76.0	36.5	162	609
1 1/4*12	6.89	8.81	31.8	44.5	183	71.5	1050	681	1132	763	90.5	46.0	196	304
1 1/4*18	6.89	11.0	31.8	44.5	183	71.5	1354	834	1424	916	90.5	46.0	196	457
1 1/4*24	6.89	12.9	31.8	44.5	183	71.5	1659	986	1741	1068	90.5	46.0	196	609
1 1/2*12	9.71	13.1	38.1	52.3	200	71.5	1105	724	1200	819	103	54.0	219	304
1 1/2*18	9.71	15.9	38.1	52.3	200	71.5	1410	876	1505	972	103	54.0	219	457
1 1/2*24	9.71	17.8	38.1	52.3	200	71.5	1715	1029	1810	1124	103	54.0	219	609
1 3/4*18	12.7	24.4	44.5	66.0	239	86.0	1407	949	1518	1061	117	60.4	254	457
1 3/4*24	12.7	27.5	44.5	66.0	239	86.0	1711	1102	1823	1214	117	60.4	254	609
2*24	16.8	40.4	51.0	66.5	301	93.5	1845	1235	1980	1370	146	68.3	332	609
2 1/9*24	27.2	68	63.5	76.5	344	113	1925	1316	2093	1483	165	79.0	350	609
2 3/4*24	34.0	83	70.0	92.2	387	106	1978	1369	2172	1562	177	82.5	387	609

US TYPE TURNBUCKLES WITH JAW & JAW

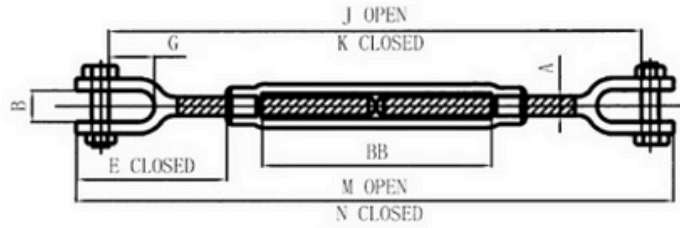

Drop Forged, Quenched and Tempered

Hot Dipped Galvanized

Proof Load is 2.5 times the Working Load Limit. Ultimate Load is 5 times the Working Load Limit.

Size(in)	WLL(T)	Weight(KG)	Dimensions(mm)								
			A	B	E Closed	G	J Open	K Closed	M Open	N Closed	BB
1/4*4	0.23	0.16	6.35	11.4	40.1	15.7	277	175	302	201	102
5/16*4.1/2	0.36	0.24	7.85	12.7	50.5	22.1	314	212	353	239	114
3/8*6	0.54	0.37	9.65	13.7	54.0	22.1	410	258	441	289	152
1/2*6	1.00	O. 71	12.7	16.5	70.0	26.9	470	292	508	330	152
1/2*9	1.00	O. 79	12.7	16.5	70.0	26.9	622	368	660	406	229
1/2*12	1.00	1.09	12.7	16.5	70.0	26.9	775	445	813	483	305
5/8*6	1.59	1.23	16.0	20.1	89.0	33.3	509	325	562	378	152
5/8*9	1.59	1.56	16.0	20.1	89.0	33.3	662	401	715	454	229
5/8*12	1.59	1.77	16.0	20.1	89.0	33.3	814	478	867	530	305
3/4*6	2.36	1.86	19.1	23.9	106	38.1	546	356	612	422	152
3/4*9	2.36	2.48	19.1	23.9	106	38.1	699	432	765	498	229
3/4*12	2.36	2.98	19.1	23.9	106	38.1	851	508	917	574	305
3/4*18	2.36	3.64	19.1	23.9	106	38.1	1156	660	1222	726	457
7/8*12	3.27	3.71	22.4	28.7	123	44.5	892	543	967	618	305
7/8*18	3.27	4.89	22.4	28.7	123	44.5	1197	675	1272	770	457
1*6	4.54	4.62	25.4	34.0	140	52.5	628	425	713	510	152
1*12	4.54	5.96	25.4	34.0	140	52.5	933	577	1018	662	305
1*18	4.54	6.87	25.4	34.0	140	52.5	1237	729	1322	814	457
1*24	4.54	8.20	25.4	34.0	140	52.5	1542	882	1627	967	610
1-1/4*12	6.89	9.34	31.8	44.5	183	71.5	1012	644	1119	750	305
1-1/4*18	6.89	11.2	31.8	44.5	183	71.5	1317	796	1423	903	457
1-1/4*24	6.89	12.8	31.8	44.5	183	71.5	1622	948	1728	1055	610
1-1/2*12	9.71	13.9	38.1	52.3	200	71.5	1054	673	1181	800	305
1-1/2*18	9.71	16.7	38.1	52.3	200	71.5	1359	826	1486	953	457
1-1/2*24	9.71	18.9	38.1	52.3	200	71.5	1664	978	1791	1105	610
1-3/4*18	12.7	24.5	44.5	66.0	239	86.0	1356	899	1503	1046	457
1-3/4*24	12.7	28.7	44.5	66.0	239	86.0	1661	1051	1808	1198	610
2*24	16.8	42.8	51.0	66.5	301	93.5	1766	1157	1949	1339	610

COMMERCIAL TYPE TURNBUCKLES

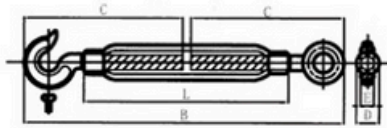

Size (mm)	WLL (kg)	Dimensions(mm)						Weight (lbs)
		B	C	D	E	F	L	
6x100	100	145	215	12	10	6	100	0.35
8x125	200	185	280	14	12	8	125	0.53
10x150	300	210	325	16	14	9	150	0.79
12x200	500	275	430	19	18	11	200	1.41
16x250	1000	345	540	23	24	14	250	3.18
20x300	1500	435	670	28	26	18	300	4.96
22x330	2200	480	740	34	32	20	330	7.79
24x350	3000	555	830	36	36	21	350	9.58

JIS TYPE FRAME TURNBUCKLES

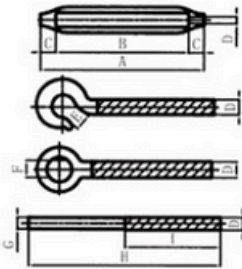

Size(D)		BodyOnly						Eye&Eye			Hook&Eye		Hook & Hook			WithStubs			
		A	B	C	T.L	W/PC	F	T.L	W/PC	T.L	W/PC	E	T.L	W/PC	H	I	G	W/PC	
mm	in	mm	in	mm	mm	t	lbs	mm	t	lbs	t	lbs	mm	t	lbs	mm	mm	mm	lbs
6	1/4	100	4	78	11	1	2.21	10	0.1	0.3	0.04	0.25	9	0.04	0.25	80	50	5.3	11.69
8	5/16	125	5	100	12.5	1.2	2.65	12	0.2	0.5	0.08	0.48	9	0.08	0.47	100	63	6.9	15.23
9	3/8	150	6	120	12.5	1.5	3.31	16	0.5	0.7	0.15	0.65	11	0.15	0.64	130	75	8.3	18.31
12	1/2	200	8	164	18	2	4.41	20	2	1.3	0.35	1.29	16	0.35	1.26	150	100	11.2	24.71
16	5/8	250	10	202	21.5	3	6.62	22	3	2.4	0.7	2.32	19	0.7	2.27	180	125	14.2	31.33
19	3/4	300	12	250	25	4	8.83	28	4	3.9	1	3.93	20	1	3.91	220	150	17.2	37.95
22	7/8	325	13	269	28	5	11.03	33	5	5.6	1.5	5.69	21	1.5	5.74	250	165	20.3	44.79
25	1	350	14	285	32.5	6	13.24	35	6	8.4	2	8.32	26	2	8.21	270	175	23.3	51.41
32	1-1/4	400	16	310	45	8	17.65	36*70	10	16.8	3	16.6	34	3	16.4	300	200	29	63.99
38	1-1/2	450	18	350	55	10	22.07	40*80	15	29.8	4	28.2	35	4	48.5	330	225	38	83.85

KOREAN TYPE TURNBUCKLE

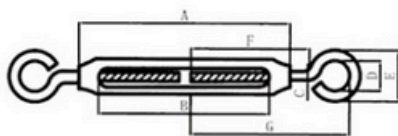

Size(in)	Dimensions(mm)							Weight(lbs)
	A	B	C	D	E	F	G	
3/16"	57.4	41.2	41.5	18.4	15	36	54.6	66
5/16"	90	70	8	11	22	65	95	320
3/8"	160	130	9	17	30	85	130	761
1/2"	190	155	10	20	30	95	150	1236
1/2"(Long)	255	215	10	30	35	140	190	1743
5/8"	250	200	15	25	45	130	190	2471
5/8"(Long)	350	300	15	30	45	180	240	3398
3/4"	250	200	20	35	45	140	210	3685
3/4" (Long)	300	245	20	40	55	170	240	4523

DIN 1480 TURNBUCKLES

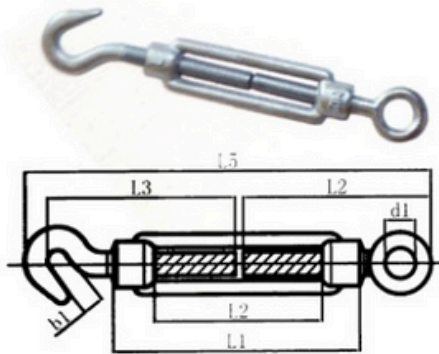

Size (mm)	Dimensions(mm)							Weight 100pcs(lbs)
	L1	L2	L3	bl	L4	d1	L5	
M6	110	80	85	8.5	80	9	172	21.0
M8	110	75	85	11	84	10	182	36.4
M10	125	85	112	13.5	105	14	213	64.0
M12	125	80	117	15.5	115	16	238	94.9
M14	140	90	122	18.5	122	18	263	136.8
M16	170	110	138	19	165	22	320	203.0
M20	200	130	170	20.5	167	24	367	359.7
M22	220	145	185	26	167	27	398	485.4
M24	255	170	205	26	205	27	447	662.0
M30	255	160	225	33	255	31	512	1015.0
M36	295	180	255	44	276	43	568	1694.6
M42	330	200	340	48	260	49	683	2846.4
M48	355	195	360	58	300	58	755	4633.7

DIN 1478 TURNBUCKLES

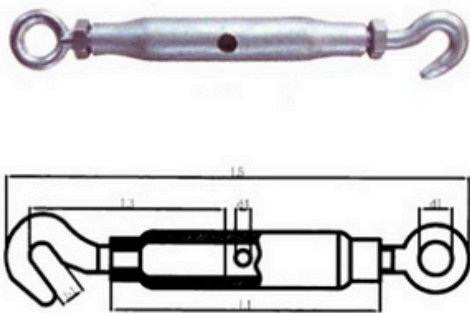

Size (mm)	Dimensions (mm)									Weight 100pcs (lbs)
	Body Length L1(mm)	Adjustable (mm)	d4	Hook		Eye		Total Length Screwed in L5		
				L3	bl	L3	d1			
M6	110	90	6	85	8.5	80	9	172	25.6	
M8	110	85	8	85	11	84	10	182	41.92	
M10	125	95	8	112	13.5	105	14	213	68.4	
M12	125	90	10	117	15.5	115	16	238	92.67	
M16	170	120	10	138	19	165	22	320	196.38	
M20	200	140	12	170	20.5	167	24	367	348.63	
M24	255	180	12	205	26	205	27	447	644.3	
M30	255	160	16	225	33	255	31	512	948.8	
M36	295	180	16	255	44	276	43	568	1334.95	
M42	330	200	20	340	48	260	49	683	2559.57	
M48	355	210	20	360	58	300	58	755	3530.45	

RIGGING SCREW

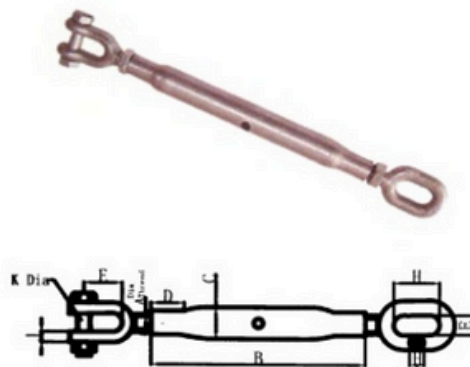

WLL (m. t)	Dimensions(mm)									Weight (lbs)	
	Dia Screw A	Length of Body B	Dia of Body C	D				E			
				JAW Length				OVALEYE Inside			
				Dia	DiaPin	Length	Hidht	Dia	Length		Hidht
D1	D2	D3	D4	E1	E2	E3					
0.1	6	102	12	3	5	15	7	6	15	8	0.24
0.15	88	110	15	4	6	16	9	7	19	10	0.5
0.375	10	152	21	5	8	21	11	8	25	11	0.62
0.5	12	175	27	6	10	25	13	11	30	14	1.76
0.75	16	229	27	10	12	40	18	14	41	16	3.09
1.125	20	229	33	12	16	45	20	16	51	22	4.41
1.6	22	305	33	15	18	48	24	16	51	22	7.72
2	24	325	42	16	22	65	28	19	57	25	8.81
2.75	28	356	48	18	22	59	30	19	57	28	9.92
3.75	33	381	48	20	27	62	34	22	65	35	14.3
4.25	35	381	60	22	28	68	38	22	65	36	17.64
5	39	406	60	24	33	74	42	25	74	38	24.25

US TYPE DROP FORGED WIRE ROPE CLIPS

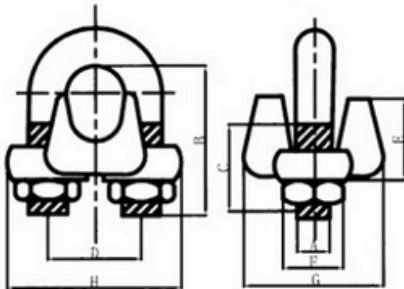

Size (in)	Dimensions(in)								Weight 100pcs(lbs)
	A	B	C	D	E	F	G	H	
1/8	0.22	0.72	0.44	0.47	0.37	0.38	0.81	0.99	6
3/16	0.25	0.97	0.56	0.59	0.50	0.44	0.94	1.18	10
1/4	0.31	1.03	0.5	0.75	0.66	0.56	1.19	1.43	19
5/16	0.38	1.38	0.75	0.88	0.73	0.69	1.31	1.66	28
3/8	0.44	1.5	0.75	1	0.91	0.75	1.63	1.94	48
7/16	0.5	1.88	1	1.19	1.13	0.88	1.91	2.28	78
1/2	0.5	1.88	1	1.19	1.13	0.88	1.91	2.28	80
9/16	0.56	2.25	1.25	1.31	1.34	0.94	2.06	2.5	109
5/8	0.56	2.25	1.25	1.31	1.34	0.94	2.06	2.5	110
3/4	0.62	2.75	1.44	1.5	1.39	1.06	2.25	2.84	142
7/8	0.75	3.12	1.62	1.75	1.58	1.25	2.44	2.16	212
1	0.75	3.5	1.81	1.88	1.77	1.25	2.63	3.47	252
11/8	0.75	3.88	2	2	1.91	1.25	2.81	3.59	283
11/4	0.88	4.44	2.22	2.34	2.17	1.44	3.13	4.13	438
13/8	0.88	4.44	2.22	2.34	2.31	1.44	3.13	4.19	442
11/2	0.88	4.94	2.38	2.59	2.44	1.44	3.41	4.44	544
15/8	1	5.31	2.62	2.75	2.66	1.63	3.63	4.75	704
13/4	1.13	5.75	2.75	3.06	2.92	1.81	3.81	5.24	934
2	1.25	6.44	3	3.38	3.03	2	4.44	5.88	1300
21/4	1.25	7.13	3.19	3.88	3.19	2	4.56	6.38	1600
21/2	1.25	7.69	3.44	4.13	3.69	2	4.69	6.63	1900
23/4	1.25	8.31	3.56	4.38	4.88	2	5	6.88	2300
3	1.5	9.19	3.88	4.75	4.44	2.38	5.31	7.61	3100
31/2	1.5	10.75	4.5	5.5	6	2.38	6.19	8.38	4000

US TYPE GALV MALLEABLE WIRE ROPE CLIPS

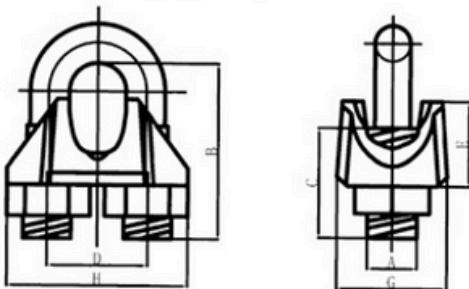

Size (in)	Dimensions(in)							Weight 100pcs (lbs)
	A	B	C	D	E	G	H	
1/8	1/4	13/16	1/2	1/2	7/16	1/2	15/16	3.3
3/16	1/4	31/32	5/8	9/16	1/2	9/16	11/16	6.6
1/4	5/16	17/32	7/8	11/16	5/8	11/16	13/8	11.42
5/16	5/16	17/32	7/8	11/16	11/16	11/16	13/8	13.1
3/8	3/8	15/8	1	7/8	13/16	7/8	15/8	22
7/16	3/8	15/8	1	7/8	13/16	15/16	15/8	25.2
1/2	7/16	2	11/4	1	11/16	1	17/8	38.4
9/16	1/2	25/16	115/32	13/16	13/16	11/8	23/16	49.73
5/8	1/2	25/16	115/32	13/16	15/16	11/8	23/16	54.76
3/4	9/16	29/16	13/4	111/32	11/2	11/4	27/16	80.53
7/8	5/8	31/16	113/16	15/8	13/4	13/4	27/8	117.35
1	5/8	33/8	21/16	13/4	115/16	2	3	150.6
11/8	3/4	37/8	23/16	21/16	23/16	21/8	37/16	243
11/4	3/4	37/8	23/16	21/16	23/8	21/2	37/16	262
13/8	7/8	41/2	2	29/16	27/8	31/8	43/16	456
11/2	7/8	41/2	2	29/16	3	31/4	41/4	512

DIN741 Malleable Wire Rope Clips

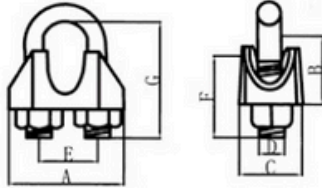

Size (mm)	Dimensions(mm)							Weight 100pcs(lbs)
	A	B	C	D	E	F	G	
3	21	10	10	4	9	12	16.6	3.09
5	23	10	11	5	11	13	19.65	3.3
6.5	26	11	12	5	13	15	23.65	4.63
8	30	15	14	6	16	19	28.85	9.04
10	34	17	18	8	19	22	35	15
11	36	18	19	8	20	22	37	15.87
13	40	21	23	10	24	30	46.24	28.7
14	44	22	23	10	25	30	48.24	29.76
16	50	26	26	12	29	33	52.5	46.3
19	54	30	29	12	32	38	64.5	61.7
22	61	34	33	14	37	44	72.5	88.2
26	65	37	35	14	41	45	82.5	97.0
30	74	43	37	16	48	50	95.6	145.5
34	80	50	42	16	52	55	105.6	187.4
40	88	55	45	16	58	60	125.6	229.3

DIN1142 Malleable Wire Rope Clips

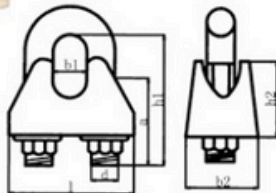

Size (mm)	Dimensions(mm)							Weight 100pcs(lbs)
	a	b1	b2	d	h1	h2	l	
5	13	7	13	5	25	13	25	5
6.5	17	8	16	6	32	14	30	9
8	20	10	20	8	41	18	39	18
10	24	12	20	8	46	21	40	20
13	30	15	28	12	64	29	55	61
16	35	18	32	14	76	35	64	95
19	36	22	32	14	83	40	68	108
22	40	24	34	16	96	44	74	150
26	50	26	38	20	111	51	84	258
30	55	34	41	20	127	59	95	309
34	60	38	45	22	141	67	105	470
40	65	44	49	24	159	77	117	591

Galv Malleable Wire Rope Clips Type A

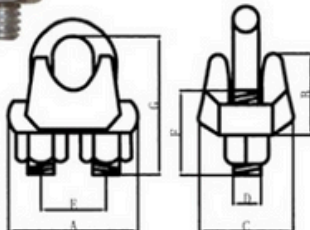

Size (mm)	Dimensions(mm)							Weight 100pcs(lbs)
	A	B	C	D	E	F	G	
6	23	14	17	5	12	14	24	5.5
8	28	17	21	6	15	16	30	9.9
10	38	21	28	8	19	20	37	19.84
12	45	27	34	10	24	25	47	39.68
15	52	32	40	12	29	30	56	61.73
20	62	38	46.5	14	36	36	70	103.62
22	69	43	51.5	16	40	39	77	136.68
25	76	50	56	18	43	44	85	187.4
28	85	57	62	20	48	48	95	264.55
32	93	61	67	22	55	51	108	346.12
40	111	73	81	24	64	62	120	575.4
45	123	86	88	27	72	70	137	800
50	135	95	95	30	80	88	154	1058.2

CLEVIS SLIP HOOKS H-331/A-331

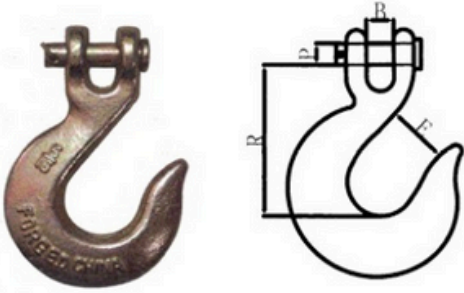

Size (in)	WLL(lbs)		Dimensions(in)				Weight (lbs)
	H-331	A-331	B	E	P	R	
1/4"	1950	2750	0.44	0.94	0.38	2.56	0.50
5 / 16"	2875	4300	0.50	1.66	0.44	2.87	0.75
3 / 8"	4000	5250	0.59	1.31	0.47	3.25	1.20
7/16"	5000	7000	0.66	1.56	0.56	3.70	2.06
1 / 2"	6500	9000	0.75	1.69	0.63	4.00	2.80
5/8"	9250	13500	0.91	2.00	0.75	4.94	4.75
3/4"	12500	19250	1.31	2.50	1.00	6.09	10.30

EYE GRAB HOOKS H-323/A-323



Size (in)	WLL(lbs)		Dimensions(in)			Weight (lbs)
	H-323	A-323	B	E	R	
1/4"	2600	3600	0.50	0.34	1.97	0.28
5/16"	3900	5400	0.56	0.44	2.25	0.45
3/8"	5400	7500	0.66	0.50	2.56	0.79
7/16"	7200	10000	0.75	0.56	2.94	1.19
1/2"	9200	12750	0.88	0.66	3.38	1.80
5/8"	12750	19000	1.06	0.78	4.11	3.30
3/4"	18500	27000	1.38	0.94	5.16	6.00

CLEVIS GRAB HOOKS H-330/A-330

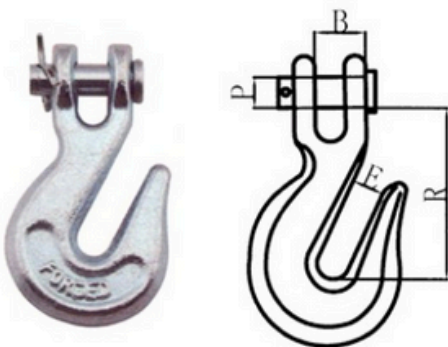

Size (in)	WLL(lbs)		Dimensions (in)				Weight (lbs)
	H-330	A-330	B	E	P	R	
1/4"	2600	3600	0.36	0.40	0.38	1.97	0.40
5/16"	3900	5400	0.40	0.44	0.44	2.26	0.79
3/8"	5400	7500	0.48	0.50	0.47	2.63	1.00
7/16"	7200	10000	0.66	0.56	0.56	2.75	1.50
1 / 2"	9200	12750	0.75	0.66	0.63	3.19	2.10
5/8"	12750	19000	0.91	0.78	0.75	4.09	4.20
3/4"	18500	27000	0.94	0.94	0.88	4.63	6.50

EYE HOOKS WITH LATCHES 320A/C

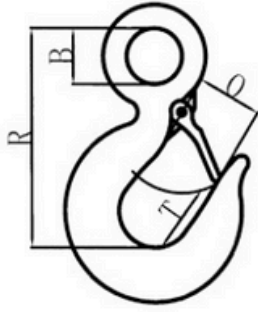

WLL(t)		Dimensions (in)				Weight(lbs)
320C	320A	B	R	O	T	
1/2	3/4	0.63	2.8	0.81	0.65	0.37
3/4	1	0.75	3.22	0.88	0.81	0.57
1	1 1/2	0.91	3.66	0.97	0.81	0.77
1 1/2	2	1.12	4.09	1	0.84	1.28
2	3	1.25	4.69	1.12	1.19	1.73
3	4 1/2	1.56	5.78	1.34	1.38	3.66
5	7	2	7.38	1.69	1.78	7.19
7 1/2	11	2.44	9.06	2.06	2.12	13.17
10	15	2.83	10.09	2.22	2.72	22.15

SWIVEL HOOKS 322A/C

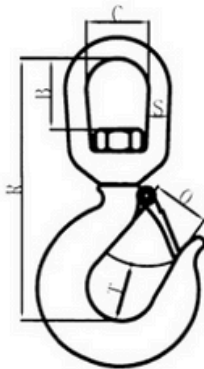

WLL(t)		Dimensions (in)						Weight (lbs)
322C	322A	B	C	O	R	S	T	
3/4	1	0.93	1.25	0.88	4.47	0.37	0.8	0.77
1	1 1/2	1.31	1.5	0.97	5.28	0.5	0.8	1.27
1 1/2	2	1.62	1.75	1	6	0.62	0.84	2.28
2	3	1.56	1.75	1.125	6.37	0.62	1.19	2.60
3	4 1/2	1.75	2	1.34	7.4	0.75	1.37	4.81
5	7	2.31	2.5	1.69	9.59	1	1.78	10.40
7 1/2	11	2.38	2.75	2.06	11.12	1.125	2.125	16.42
10	15	2.8	3.12	2.25	11.93	1.25	2.5	23.40

CLEVIS SLIP HOOKS WITH LATCHES

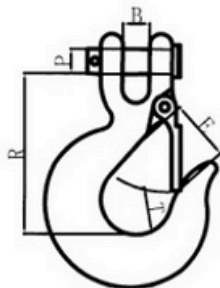

Size (in)	WLL(lbs)		Dimensions (in)					Weight (lbs)
	Carbon	Alloy	B	E	P	R	T	
1/4"	1950	2750	0.44	0.79	0.38	2.56	0.79	0.52
5/16"	2875	4300	0.50	0.93	0.44	2.87	0.79	0.77
3/8"	4000	5250	0.59	1.14	0.47	3.25	1.02	1.23
7/16"	5000	7000	0.66	1.18	0.56	3.70	1.06	2.10
1/2"	6500	9000	0.75	1.42	0.63	4.00	1.38	2.85
5/8"	9250	13500	0.91	1.65	0.75	4.94	1.69	5.18

G80 CLEVIS Self-locking HOOK

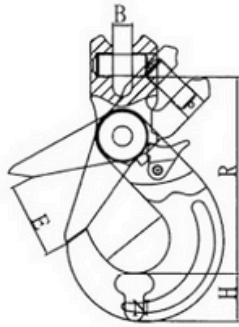

SIZE(mm)	WEIGHT (KG) 单重	WLL(T) 工作拉力	B. L (T)	E±2	B+0.5	H+1	N ±1.5	R
6-8	0.5	1.12	4.48	29	8.5	19.5	34	95.5
7/8-8	0.8	2	8	34	9.5	24	46	121
10-8	1.5	3.15	12.6	44	12	30	56	146
13-8	2.8	5.3	21.2	52	15	40	69	182
16-8	5.6	8	32	60	18	50.5	86	218
20-8	7.5	12.5	50	83	25	55	100	240
22-8	11.5	15	60	88	25.5	67	98	276.5
26-8	18.15	21.2	84.8	95.5	30	75	110	310.5
32-8	49.1	31.5	126	160	36	97	166	400.5

G80 EYE Self-locking HOOK

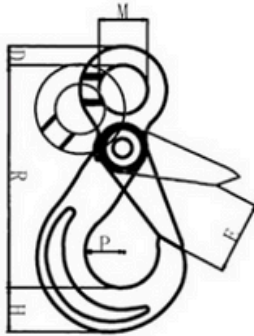

Size(mm)	Weight (lbs)	WLL(t)	B. L(t)	Dimensions(in)					
				M	R	D	P	H	E
6-8	1.1	1.12	4.48	22	110.5	10	34	19.5	28
7/8-8	1.8	2	8	25	136	12	46	24	34
10-8	3.2	3.15	12.6	32	171	15	56	30	44
13-8	6.3	5.3	21.2	40.5	208.5	19.5	69	40	52
16-8	12.4	8	32	56	257.5	22	86	50.5	60
18/20-8	16.8	12.5	50	64.5	275	27	100	55	81
22-8	28.7	15	60	70	320	30	98	67	82
26-8	39.7	21.2	84.8	80	363	34	110	75	110
32-8	98.2	31.5	126	105	472	45	166	97	168

G80 SWIVEL Self-locking HOOKS

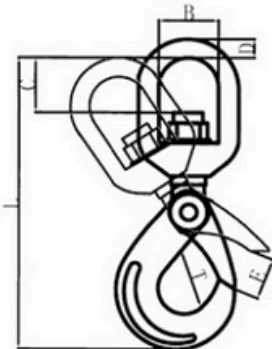

Size (mm)	Weight (lbs)	WLL(t)	B. L(t)	Dimensions in)					
				B	C	D	L	T	E
6-8	1.6	1.12	4.48	32.5	22	11.25	170	34	29
7/8-8	2.4	2	8	35.5	26	12.5	210	46	34
10-8	4.4	3.15	12.6	42	34	15	247	56	44
13-8	8.8	5.3	21.2	50	38.5	16	302	69	52
16-8	16.1	8	32	61	55	21.5	383	86	60
18/20-8	25.6	12.5	50	72	61	26	418	100	83
22-8	35.3	15	60	95	95	33	527	98	88
26-8	47.4	21.2	84.8	122	115	42	610	110	95.5
32-8	174.3	31.5	126	140	126	52	777	166	150

G80 CLEVIS SLING HOOK

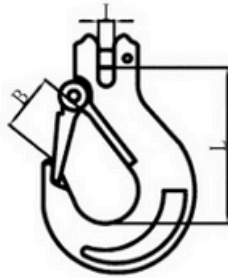

Size(mm)	Chain Size(mm)	WLL(t)	Test Load(t)	Die B	mensions(mm)		Weight (lbs)
					L	I	
6-8	5-6	1.1	2.2	22	73	6.7	0.66
7/8-8	7-8	2	4	25.5	86	8.7	1.21
10-8	10	3.15	6.3	30.8	105	10.2	2.32
13-8	13	5.3	10.6	41	128	15.3	4.19
16-8	16	8	16	50	155	19	7.83
20-8	19-20	12.5	25	60	184	21	13.04
22-8	22	15	30	71	222	36	16.1

G80 EYE SLING HOOK

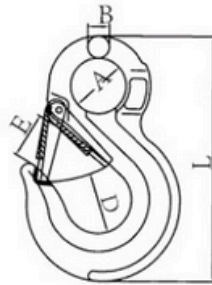

SIZE(mm)	WEIGHT (KG) 单重	WLL(T) 工作拉力	B. L(T)	B+1	E+1	D±1	A+1	L+2
6-8	0.3	1.12	4.48	9	24	21	20	108
7/8-8	0.4	2.0	8.0	11	30	26	25	133
10-8	0.9	3.15	12.6	15	34	39	38	167
13-8	1.7	5.3	21.2	19	39	54	43	213
16-8	3.2	8	32	23	46	64	50	255
20-8	5.8	12.5	50	24	40	80	62	305
22-8	8.5	15	60	32	71	80	62	348
26-8	13	21.2	84.8	35	81	82	64	394
32-8	17	31.5	126	37	102	112	88	480

G80 EYE HOOK

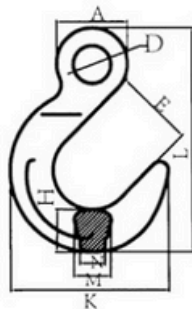

SIZE(mm)	WEIGHT (KG) 单重	WLL(T) 工作拉力	B. L(T)	E ±1.2	A ±1	D ±1	H ±1	M +1	N +0.5	K +2	L +2
7/8-8	1.09	2	8	63.5	39	18	31	25.4	18	120	163
10-8	2.04	3.15	12.6	76	50.8	22	38	32.6	23	146	200
13-8	3.22	5.3	21.2	89	63.5	27	44.5	38.1	27	171	238
16-8	5.53	8	32	102	76	32	52	46	32	198	278
20-8	8.75	12.5	50	114.5	89	38	65	55	39	232	325
22-8	11.93	15	60	127.5	102	45	69	57	40	256	361
26-8	16.8	21.2	84.8	140	126	67.5	77	66	45	283	402
32-8	26.6	31.5	126	153.5	151.5	81.5	97.5	80	58	327	461

MASTER LINK

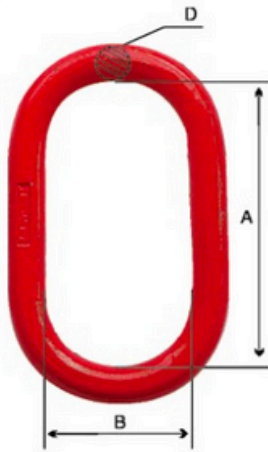

ITEM NO.in	WEIGHT/KG	WLL / T	B. L / T	Amm	Bmm	Dmm
1/2	0.42	2.2	11	127	63.5	14
5/8	0.67	3.0	15	152	76	16
3/4	1.05	4.7	23.5	140	70	19
7/8	1.5	6.4	32	162	91	23
7/8	2.66	8	40	178	89	22
1	2.07	11	55	220	110	32
1-1/4	4.16	16	80	270	140	38
1-1/2	6.55	21.7	108.5	305	152	45
1-3/4	11.37	28.4	142	350	190	50
2	16.5	30	150	355	178	50
2-1/2	32	50	250	406	203	63

MASTER LINK ASSEMBLY

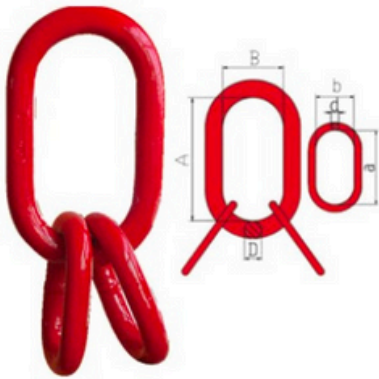

ITEMNO.	WEIGHT/KG	CHAIN(4:1)		CHAIN(5:1)		A	B	D	a	b	d	s
		WLL/T	B.L/T	WLL/T	B.L/T							
1/2	0.82	2.4	9.6	2	10	100	60	14	85	40	12	6
11/16	1.60	3.2	12.8	2.5	12.5	160	90	18	100	60	14	7.6
3/4	1.95	5	20	4	20	160	90	20	100	60	14	7.6
7/8	3.16	8	32	6.4	32	180	100	22	150	70	18	8.4
1-1/8	6.75	12	48	9.6	48	270	140	28	160	90	22	13.5
1-1/4	9.31	17.4	69.6	13.9	69.5	270	140	32	180	100	25	16.5
1-1/2	18.4	21	84	21	105	300	160	40	270	140	31	-
1-3/4	26.4	30	120	30	150	340	180	45	285	155	36	-
2	42.91	40	160	40	200	350	190	51	340	180	45	-

FORGED RING

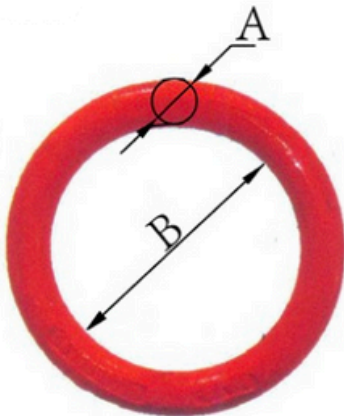

SIZE	WEIGHT (KG)	WLL	A	B
3/4*4	1.14	1.8T	19	102
7/8*4	1.6	3.5T	22	102
7/8*4	1.6	3.5T	22	140
1*4	1.6	4.5T	25	102
1-1/8*6	2.8	6.5T	28	152
1-1/4*6	3.6	9T	32	152
1-1/4*10	6	9T	32	254
1-1/2*6	5.4	10T	35	152
1-1/2*8	6.8	10T	38	203
1-1/2*10	8.4	10T	38	254

G80 EUROPEAN TYPE CONNECTING LINK

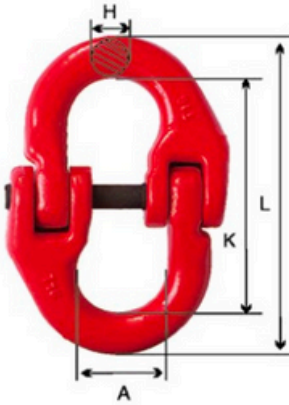

ITEM NO.	mm	WEIGHT/KG	WLL/T	B.L/T	Amm	Lmm	Kmm	Hmm
6		0.68	1.12	4.48	15	58	42	7
7		0.145	1.5	6	19	71.8	54.8	8.5
7-8		0.146	2	8	18	79.5	62.5	8.5
8		0.16	2	8	18	79.5	60.5	8.5
10		0.3	3.15	12.6	25	93	68	10.8
13		0.7	5.3	21.2	29	117	87	15
16		1.1	8	32	34.5	148	108.4	19.8
18		1.84	10	40	38	154	112	21
18-20		1.8	12.5	50	41	169.5	121.5	24
22		3.2	15	60	48	193.5	141.5	26
26		4.5	21.2	84.8	57.5	229	158	30
32		9	31.5	126	67	281	205	37

DIN 580 EYE BOLT

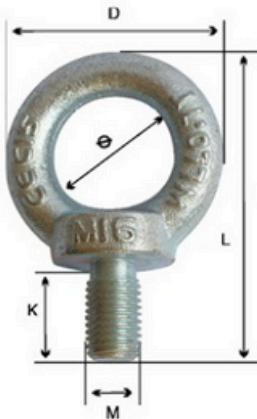

ITEM NO.	WEIGHT/KG	WLL/T(4:1)		Dmm	Kmm	φ mm	Lmm
		WLL 0°	WLL 90°				
M6	0.05	0.4	0.15	28	13	16	42
M8	0.06	1	0.4	36	15	20	51
M10	0.11	1	0.4	45	18	25	63
M12	0.18	2	0.75	54	22	30	75
M16	0.28	4	1.5	63	28	35	88
M20	0.45	6	2.3	72	30	40	101
M24	0.87	8	3.2	90	38	50	128
M30	1.66	12	4.5	108	45	60	154
M36	2.65	16	7	126	55	70	183
M42	4.03	24	9	144	65	80	212
M48	6.38	32	12	166	70	90	238

DIN 580 EYE NUT

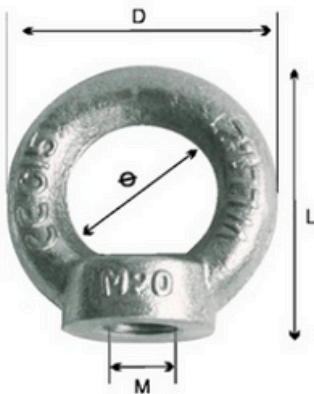

ITEM NO.	WEIGHT/KG	WLL/T(4:1)		Dmm	φ mm	Lmm
		WLL 0°	WLL 90°			
M6	0.049	0.4	0.15	36	20	36
M8	0.05	1	0.4	36	20	36
M10	0.09	1	0.4	45	25	45
M12	0.16	2	0.75	54	30	53
M16	0.24	4	1.5	63	35	62
M20	0.36	6	2.3	72	40	71
M24	0.72	8	3.2	90	50	90
M30	1.32	12	4.5	108	60	109
M36	2.08	16	7	126	70	128
M42	3.11	24	9	144	80	147
M48	5.02	32	12	166	90	168